

X-ONE

ENTRY

X110.3900.x

Composition complète
Complete composition

www.celette.com

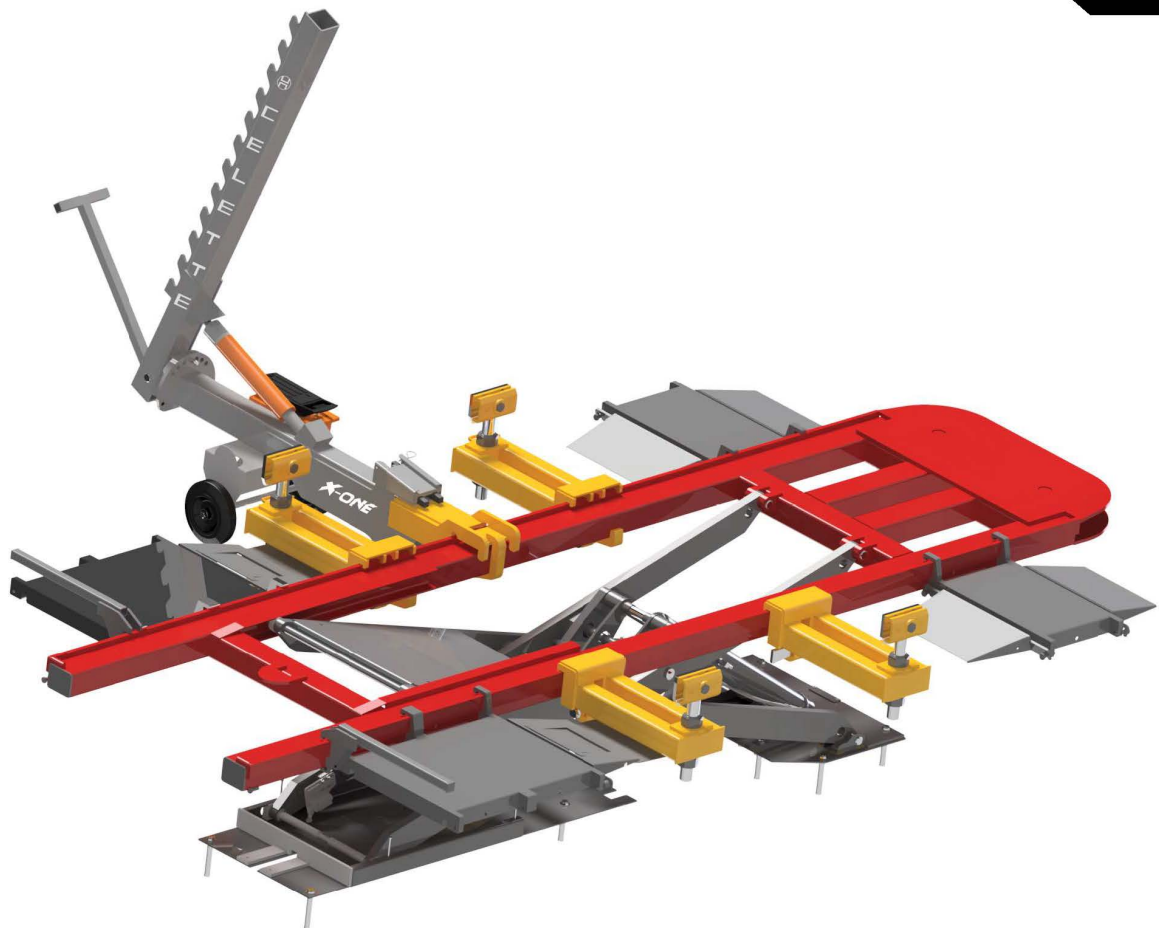

Table élévatrice de traction adaptée pour toutes les réparations de chocs urbains. Une fois positionné sur la table élévatrice, le véhicule peut être facilement et rapidement levé par les roues permettant ainsi aux techniciens d'avoir accès aux points d'ancrage.

Lifting table specially designed for light and cosmetic impact repairs. Once positioned on the table, the vehicle can be easily and rapidly lifted up by the wheels enabling the technician to get access to the anchoring points.

X-ONE

ENTRY

LX02.0320
Accessoires de traction latérale
Side traction accessories

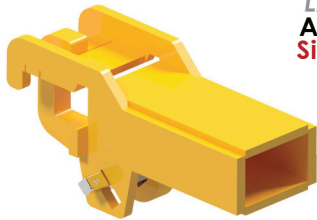

X110.0600 x 3
Jeu de paniers rigides
Set of rigid basket

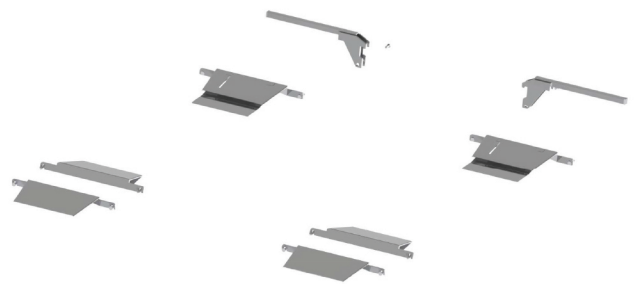
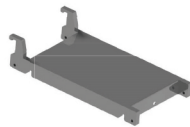

X110.0605
Jeu de 6 mini rampes
Set of 6 mini ramps



APS08.0600
Equerre de traction
Pulling Unit

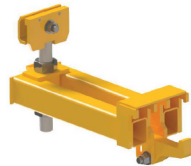

X110.0400
Jeu de 4 pinces + bras
Set of 4 clamps and arms

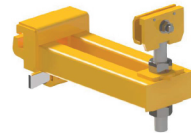
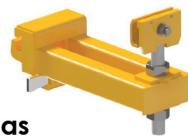

X110.1800.x
Table élévatrice (200 bars)
Lifting table (200 bars)

Phone: (02) 9772 9000
<https://shop.sape.com.au/products/CXONE>

